

Varenummer: 03555030

Beskrivelse: Fluro hydraulik ledhoved FS 30C

Mål

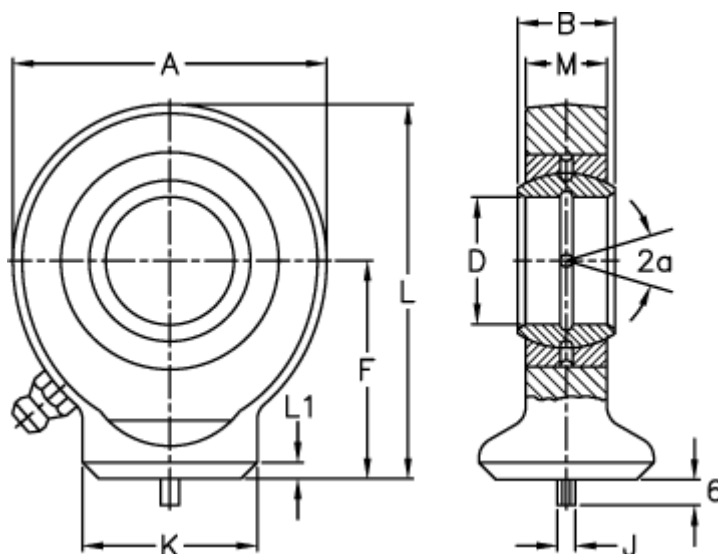

A	= 73	L	= 87.5
a (grader)	= 6	L1	= 4
B	= 22	M	= 19
D	= 30	Statisk belastning C0 (kN)	= 95
Dynamisk belastning C (kN)	= 62	Vægt	= 675
F	= 51		
J	= 4		
K	= 40		